

USER MANUAL



All-in-one solar charge inverter

ASF4880S180-H

ASF48100S200-H

Table of Contents

1. Safety

1.1 How to use this manual	4
1.2 Symbols in this manual	4
1.3 Safety Instruction	4

2. Production Instructions

2.1 Instructions	4
2.2 Features	5
2.3 System connection diagram	6
2.4 Production Overview	7

3. Installation

3.1 Select the mount location	8
3.2 Mount the inverter	9
3.3 Remove the terminal cover	9

4. Connection

4.1 Connection overview	10
4.2 Cable & circuit breaker requirement.....	12
4.3 AC input&output connection.....	15
4.4 Battery connection	15
4.5 PV connection	16
4.6 Dry contact connection	17
4.7 Grounding connection	17
4.8 Final assembly.....	17
4.9 Start up the inverter	17

5. Operation

5.1 Operation and display panel	18
5.2 Setting	22
5.3 AC output mode	27
5.4 Battery charging mode	28
5.5 Time-slot charging/discharging function	29
5.6 Battery parameter	30

Table of Contents

6. Communication

6.1 Overview	32
6.2 USB-B port	32
6.3 RS485-1 port	33
6.4 CAN/RS485-2 port	33
6.5 Dry contact	34

7. Fault and Remedy

7.1 Fault code	35
7.2 Troubleshooting.....	36

8. Protection and Maintenance

8.1 Protection features	38
8.2 Maintenance	39





9. Datasheet

1. Safety

1.1 How to use this manual

- This manual contains important information, guidelines, operation and maintenance for the following products: ASF series 4880S180–H, 48100S200–H
- The manual must be followed during installation and maintenance.

1.2 Symbols in this manual

Symbol	Description
 DANGER	DANGER indicates a hazardous situations which if not avoided will result in death or serious injury.
 WARNING	WARNING indicates a hazardous situations which if not avoided could result in death or serious injury.
 CAUTION	CAUTION indicates a hazardous situations which if not avoided could result in minor or moderate injury.
 NOTICE	NOTICE provide some tips on operation of products.

1.3 Safety instructions

DANGER

- This chapter contains important safety instructions. Read and keep this manual for future reference.
- Be sure to comply the local requirements and regulation to install this inverter.
- Beware of high voltage. Please turn off the switch of each power sources before and during the installation to avoid electric shock.
- For optimum operation of this inverter, please follow required specification to select appropriate cable size and necessary protective device.
- Do not connect or disconnect any connections when the inverter is working.
- Do not open the terminal cover when the inverter working.
- Make sure the inverter is well grounding.
- Never cause AC output and DC input short circuited.
- Do not disassembly this unit, for all repair and maintenance, please take it to the professional service center.
- Never charge a frozen battery.
- Please keep children away from touching or mishandling the inverter.
- Please make sure that this inverter is the only input power source for the load, do not use it in parallel with other input AC power sources to avoid damage.

2. Production Instructions

2.1 Instructions

ASF series is a new type of solar energy storage inverter control inverter integrating solar energy storage & utility charging and energy storage, AC sine wave output. It adopts DSP control and features high response speed, reliability, and industrial standard through an advanced control algorithm.

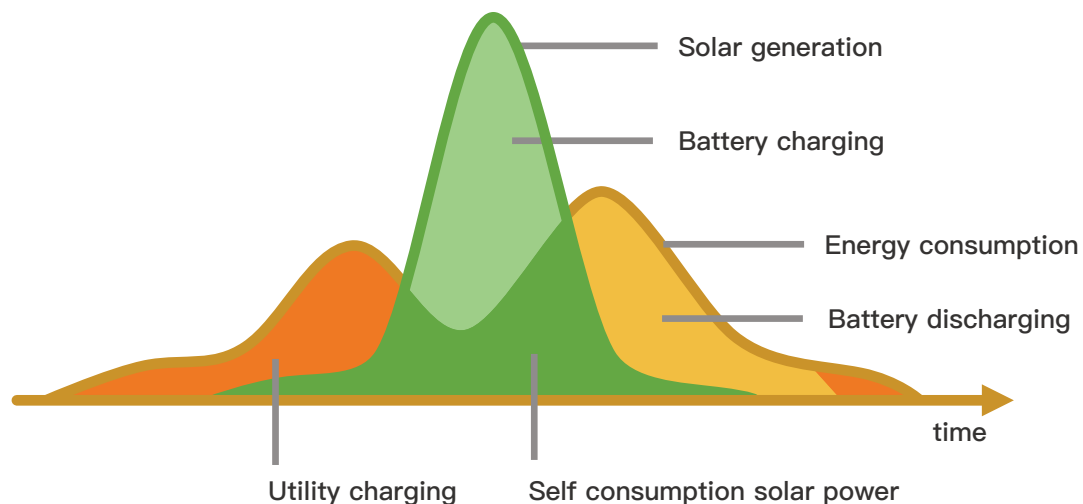

2.2 Features

- Supports lead acid battery and li-ion battery connections.
- With a dual activation function when the li-ion battery is dormant; either mains/photovoltaic power supply access can trigger the activation of the li-ion battery.
- Support split-phase and single-phase pure sine wave output.
- Supports four different voltage levels of 200\208\220\230\240Vac per phase.
- Supports two solar inputs and simultaneous tracking of two solar maximum power charging/carrying capacity functions.
- Dual MPPT with 99.9% efficiency and maximum 22A current in a single circuit, perfectly adapted to high power modules.
- 4 charging modes are available: solar only, mains priority, solar priority, and mixed mains/PV charging.
- With the time-slot charging and discharging setting function, you can set the time period for cutting in/out of mains charging and switch the time period between battery discharging and mains bypass power supply mode.
- Energy saving mode function to reduce no-load energy losses.
- With two output modes of utility bypass and inverter output, with uninterrupted power supply function.
- LCD large screen dynamic flow diagram design, easy to understand the system data and operation status.
- 360° protection with complete short circuit protection, over current protection, over under voltage protection, overload protection, backfill protection, etc.
- Support CAN, USB, and RS485 communication.

2.3 System connection diagram

The diagram below shows the system application scenario of this product. A complete system consists of the following components:

1. **PV modules:** converts light energy into DC energy, which can be used to charge the battery via an inverter or directly inverted into AC power to supply the load.
2. **Utility grid or generator:** connected to the AC input, it can supply the load and charge the battery at the same time. The system can also operate generally without the mains or generator when the battery and the PV module power the load.
3. **Battery:** The role of the battery is to ensure the regular power supply of the system load when the solar energy is insufficient and there is no mains power.
4. **Home load:** Various household and office loads can be connected, including refrigerators, lamps, televisions, fans, air conditioners, and other AC loads.
5. **Inverter:** The energy conversion device of the whole system.

The actual application scenario determines the specific system wiring method.

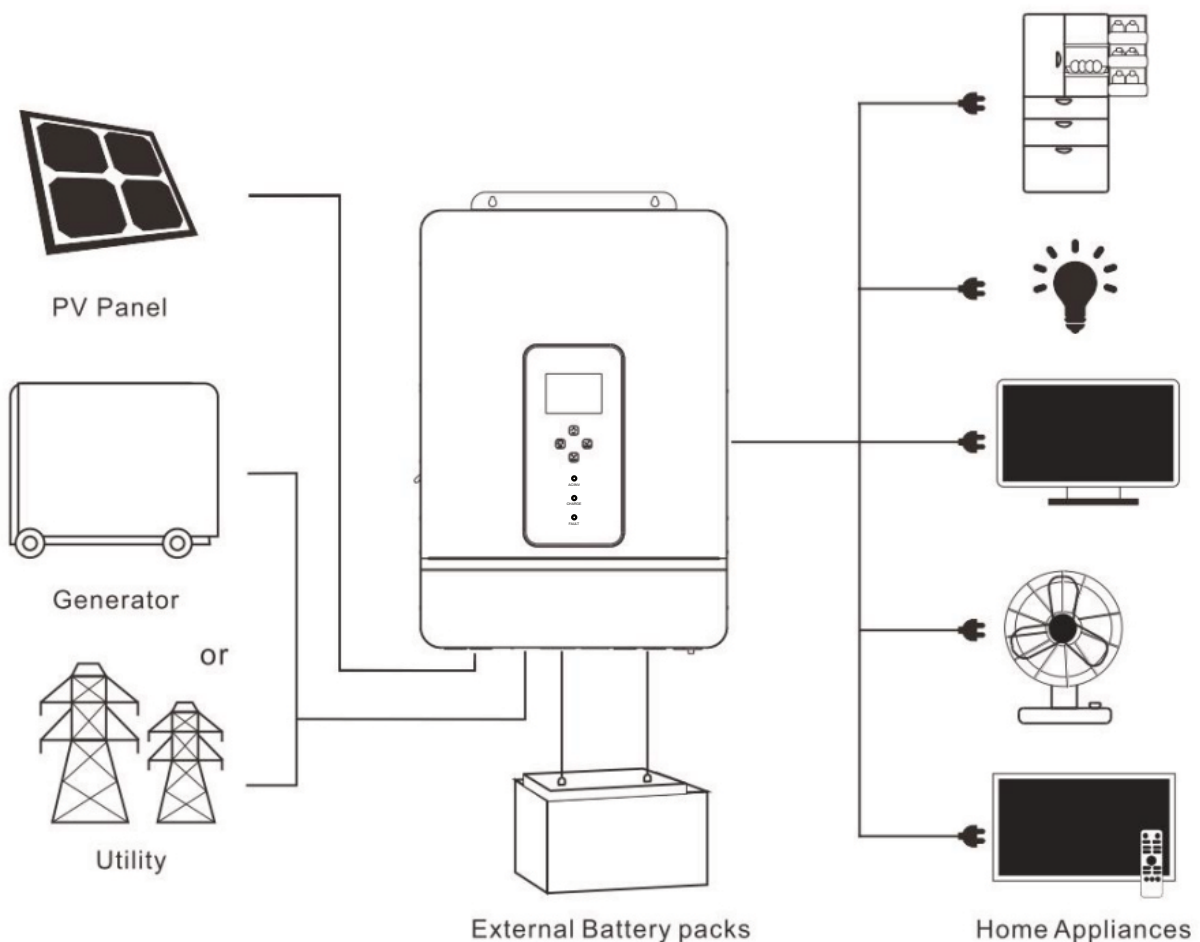

2.4 Production Overview

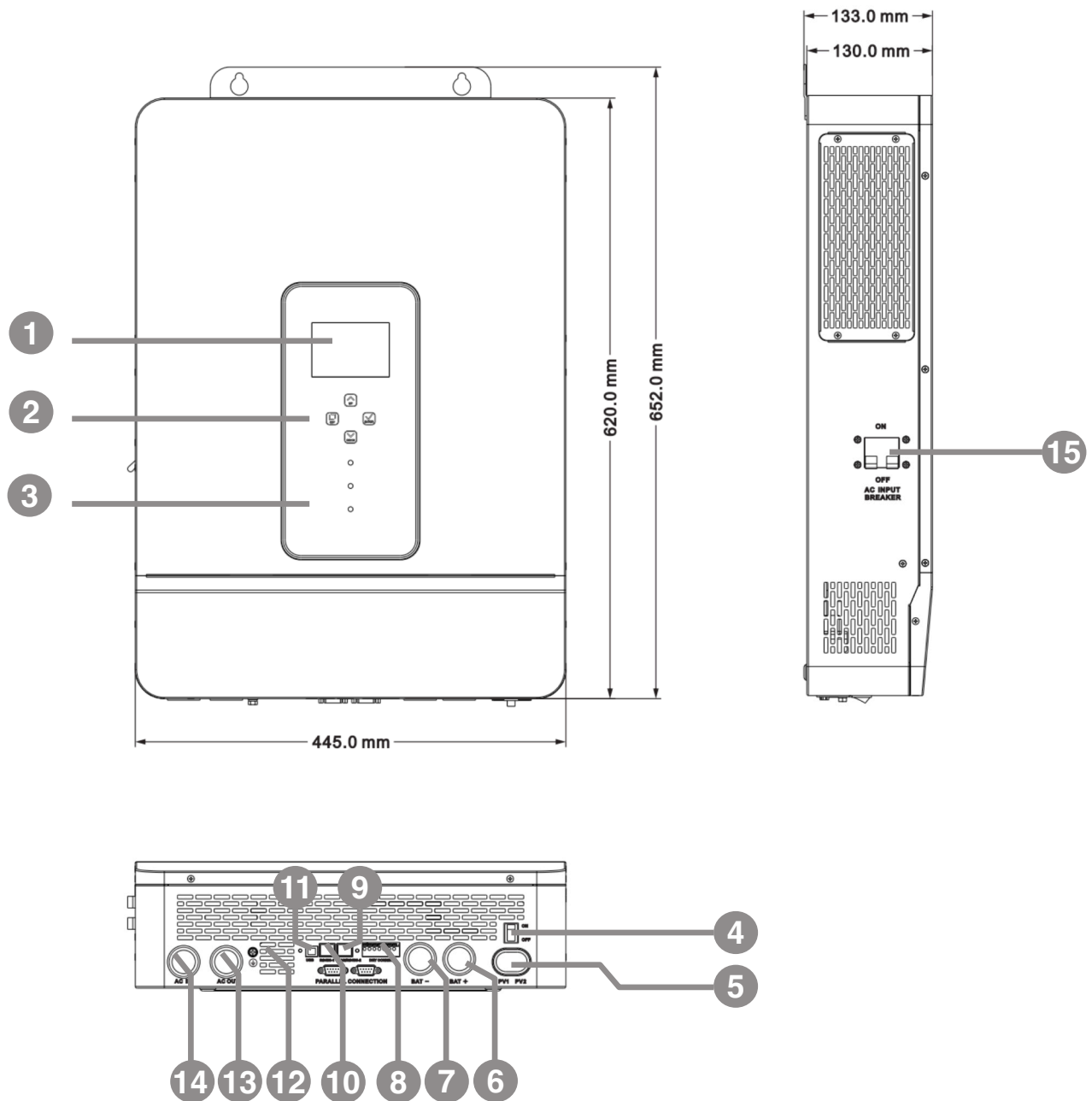

1	LCD screen	2	Touchable key	3	LED Indicators
4	ON/OFF Rocker Switch	5	PV INPUT (1/1)	6	BAT INPUT (+)
7	BAT INPUT (-)	8	Dry contact	9	CAN/RS485-2 port
10	RS485-1 port	11	USB-B port	12	Grounding Screw
13	AC OUT (L+N)	14	AC IN (L+N)	15	AC INPUT breaker

3. Installation

3.1 Select the mount location

ASF series are designed for **INDOOR USE ONLY** (IP20) . Please consider the followings before selecting the location.

- Choose the solid wall to install the inverter.
- Mount the inverter at eye level.
- Adequate heat dissipation space must be provided for the inverter.
- The ambient temperature should be between $-10\sim 55^{\circ}\text{C}$ ($14\sim 131^{\circ}\text{F}$) to ensure optimal operation.

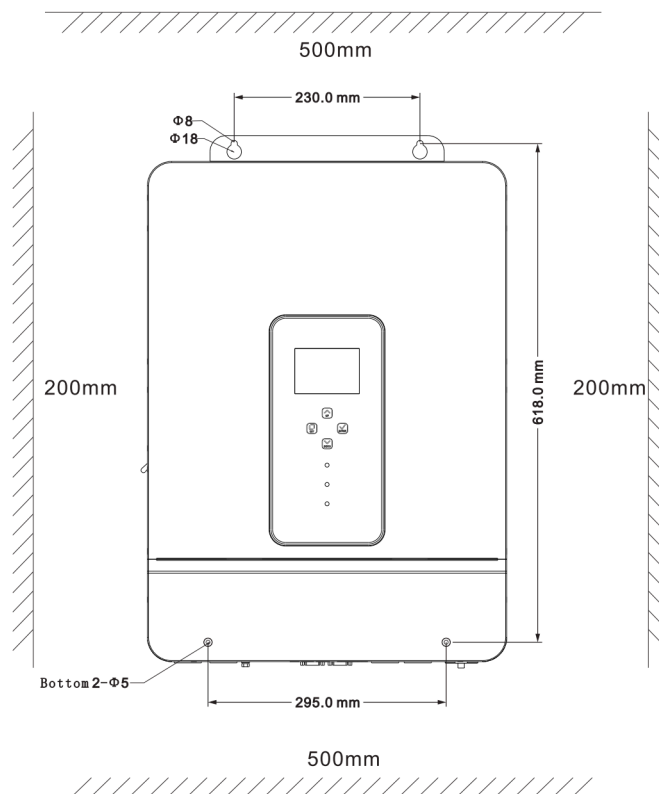

⚠ DANGER

- Do not install the inverter where highly flammable materials are near by.
- Do not install the inverter in potential explosive areas.
- Do not install the inverter with lead-acid batteries in a confined space.

⚠ CAUTION

- Do not install the inverter in direct sunlight.
- Do not install or use the inverter in a humid environment.

3.2 Mount the inverter

Make 4 mounting holes in the wall with a drill according to the specified dimensions, insert two expansion screws above and two M5 size screws below for fixing the inverter.

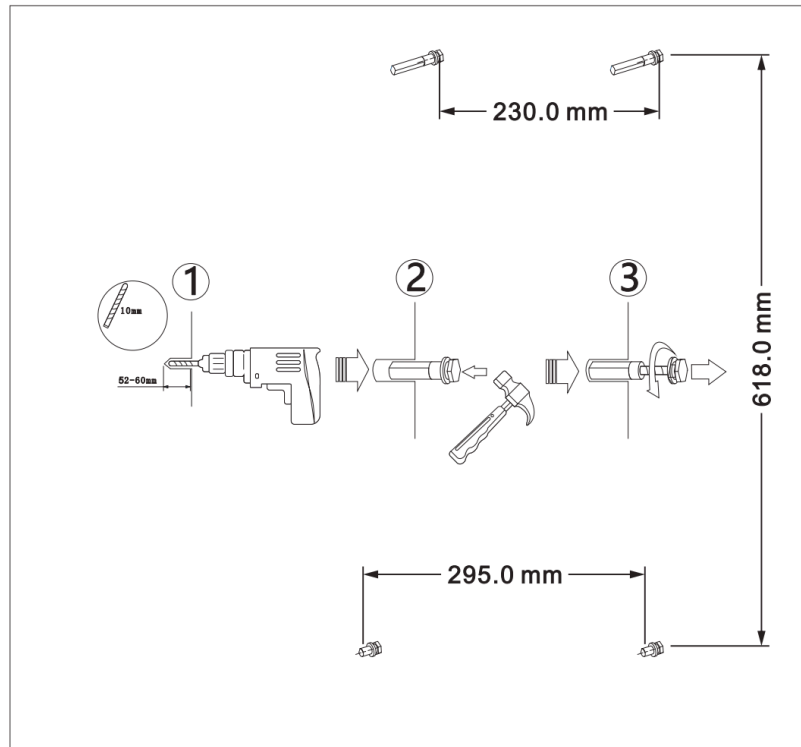

3.3 Remove the terminal cover

Using a screwdriver, remove the terminal protection cover.

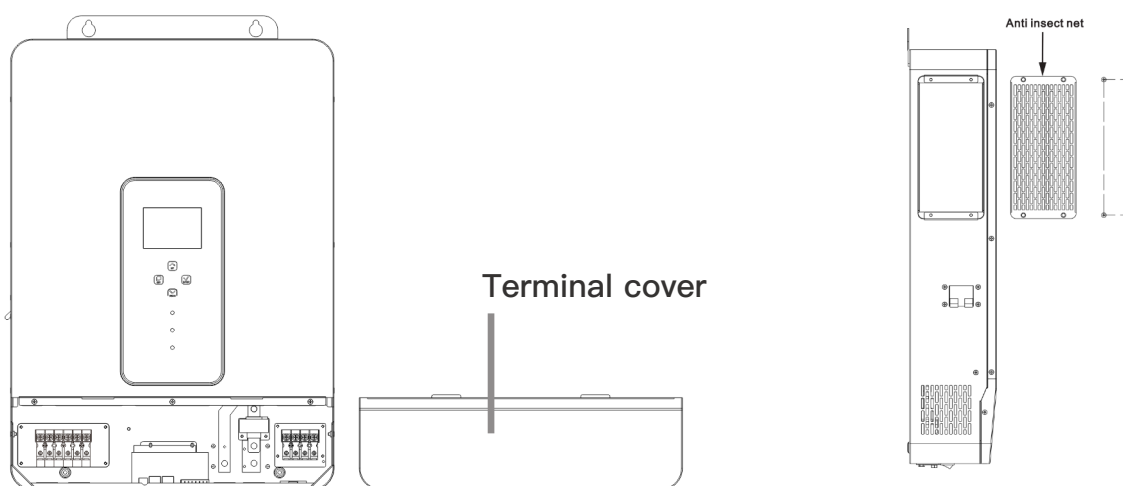

! NOTICE

- When using the device in areas with poor air quality, the dust screen is easily blocked by airborne particles. Please dismantle and clean the dust screen regularly to avoid affecting the internal air flow rate of the inverter, which may trigger an over-temperature protection fault (19/20 fault) affecting the use of the power supply and the service life of the inverter.

4. Connection

4.1 Single-phase output

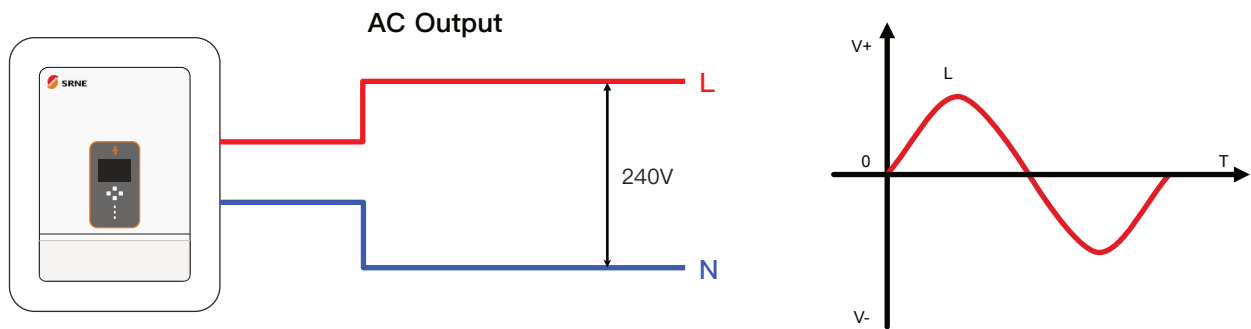

Items	Description
Applicable Model	ASF series S model
Output Voltage Range (L-N)	200~240Vac, 230Vac default

NOTICE

- Users can change the output voltage by setup menu. Please read the chapter 5.2 Setting.
- Output voltage corresponds parameter ⌘ , the output voltage can be set from 200V to 240V.

Single-phase Mode

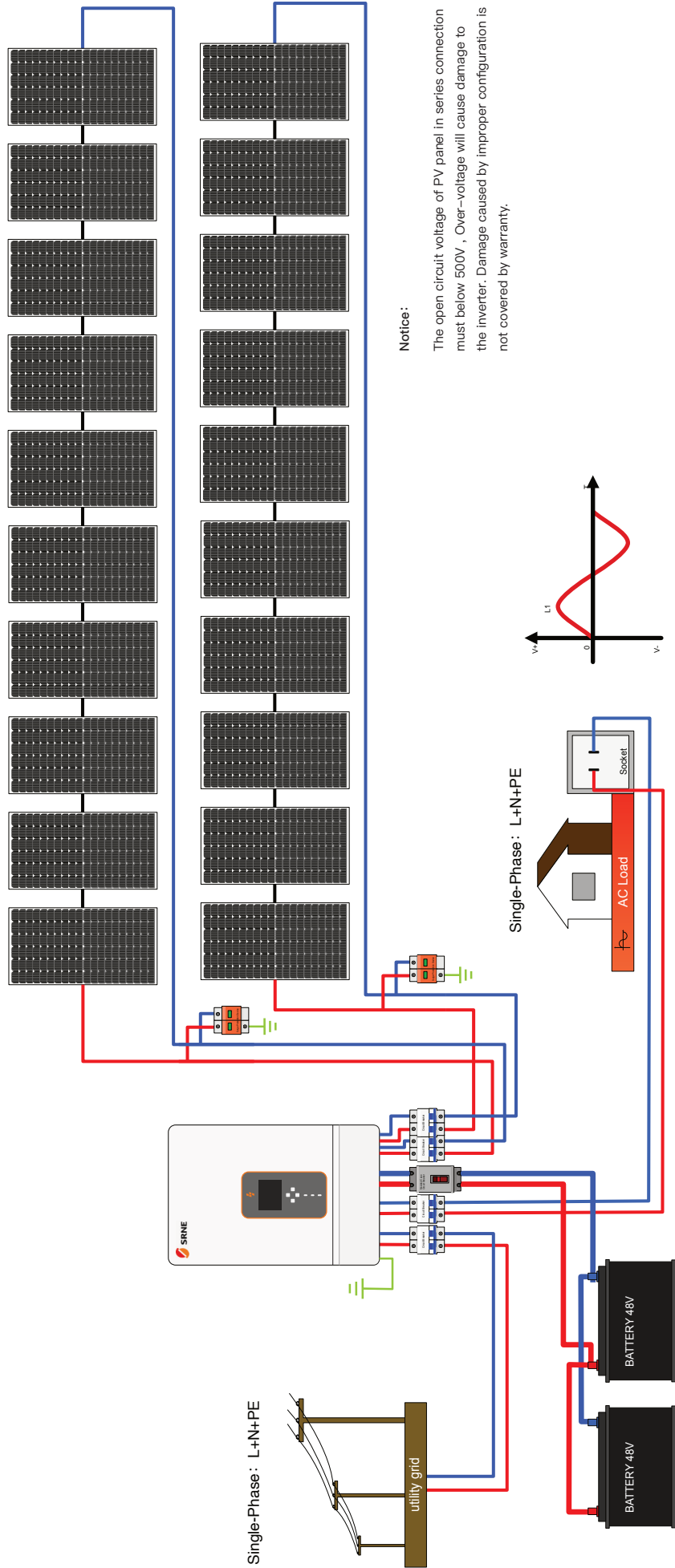

4.2 Cable & circuit breaker requirement

- PV INPUT**

Model	Cable Diameter	Max.PV Input Current	Circuit Breaker Spec
ASF4880S180-H	5mm ² / 10 AWG	22A	2P-25A
ASF48100S200-H	5mm ² / 10 AWG	22A	2P-25A

- AC INPUT**

Model	Output Mode	Max.Input Current	Cable diameter	Circuit Breaker Spec
ASF4880S180-H	Single-phase	63A (L/N)	13mm ² / 6AWG	2P-63A
ASF48100S200-H	Single-phase	63A (L/N)	13mm ² / 6AWG	2P-63A

- BATTERY**

Model	Cable Diameter	Max.Battery Current	Circuit Breaker Spec
ASF4880S180-H	34mm ² / 2 AWG	180A	2P-200A
ASF48100S200-H	42mm ² / 1 AWG	220A	2P-250A

- AC OUTPUT**

Model	Output Mode	Max.Output Current	Cable diameter	Circuit Breaker Spec
ASF4880S180-H	Single-phase	63A (L/N)	13mm ² / 6AWG	2P-63A
ASF48100S200-H	Single-phase	63A (L/N)	13mm ² / 6AWG	2P-63A

NOTICE

- PV INPUT、AC INPUT、AC OUTPUT**

1. Use a stripper to remove the 6~8mm insulation of the cable.
2. Fixing a ferrule at the end of the cable. (ferrule needs to be prepared by the user)

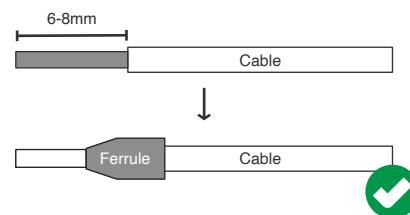

- BATTERY**

1. Use a stripper to remove the 6~8mm insulation of the cable
2. Fixing cable lugs that supply with the box at the end of the cable.

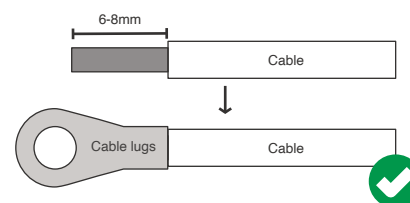

The wire diameter is for reference only. If the distance between the PV array and the inverter or between the inverter and the battery is long, using a thicker wire will reduce the voltage drop and improve the performance of the system.

4.3 AC input & output connection

Connect the live, neutral and ground wires according to the cables' position and order shown in the diagram below.

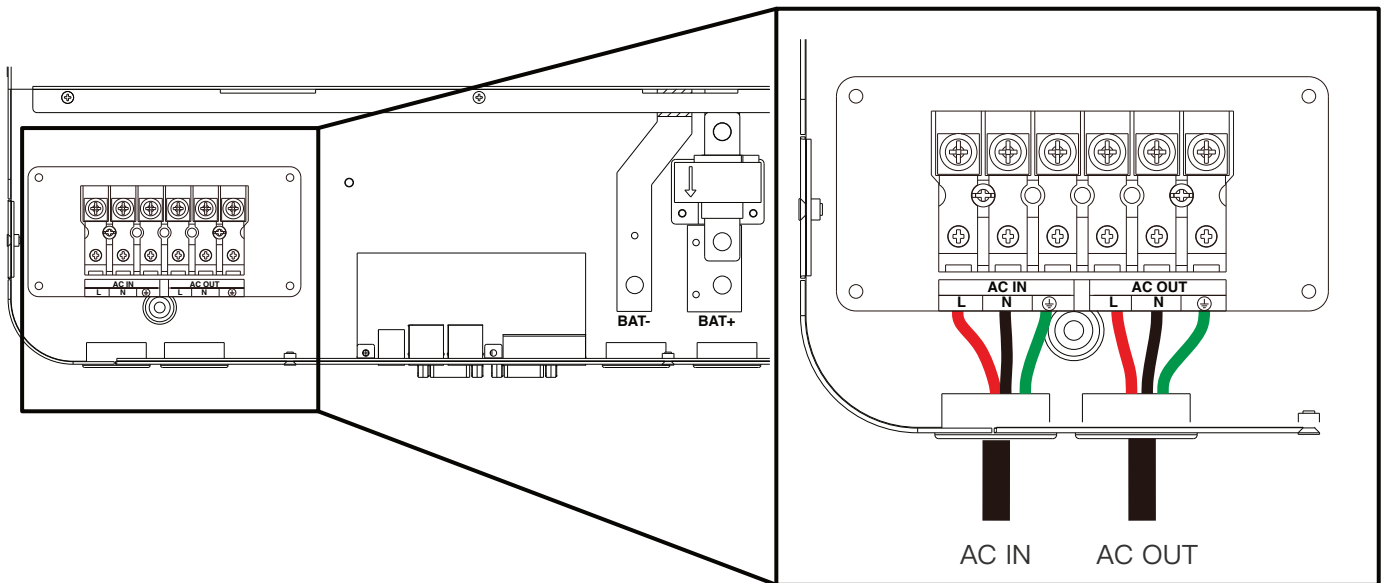

⚠ DANGER

- Before connecting AC inputs and outputs, the circuit breaker must be opened to avoid the risk of electric shock and must not be operated with electricity.
- Please check that the cable used is sufficient for the requirements, too thin, poor quality cables are a serious safety hazard.

4.4 Battery Connection

Connect the positive and negative cable of the battery according to the diagram below.

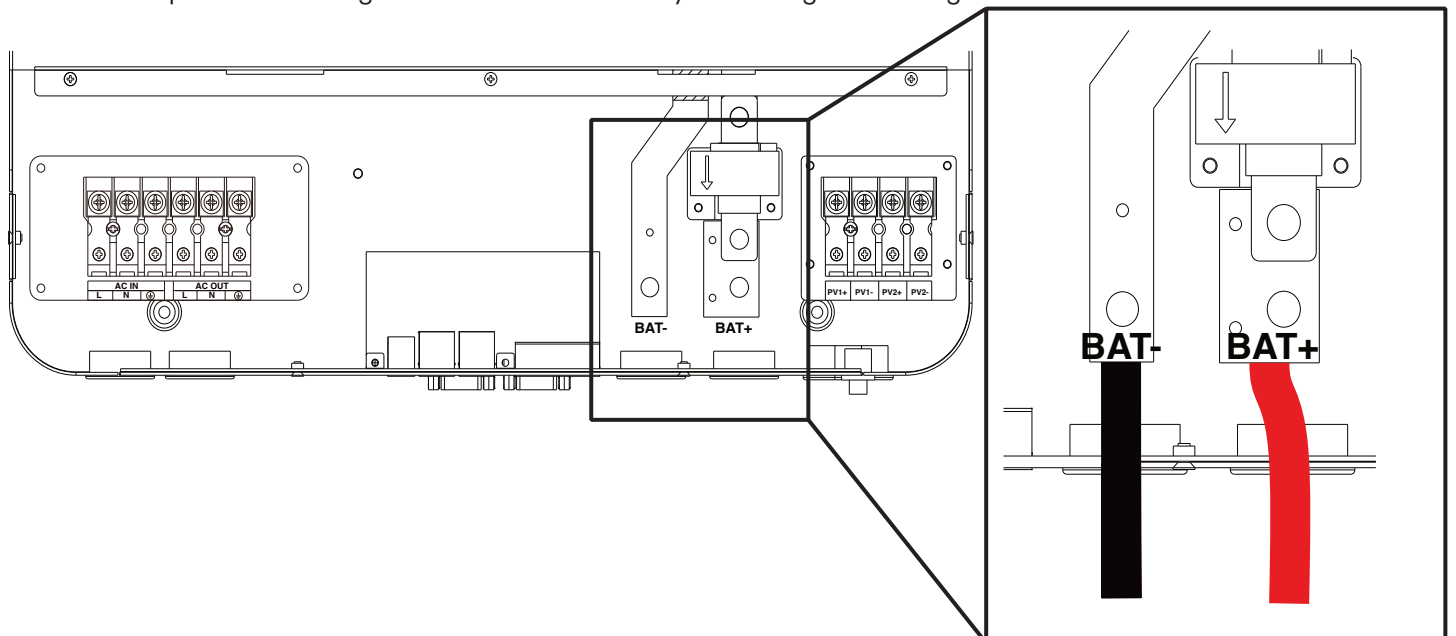

⚠ DANGER

- Before connecting battery, the circuit breaker must be opened to avoid the risk of electric shock and must not be operated with electricity.
- Make sure that the positive and negative terminals of the battery are connected correctly and not reversed, otherwise the inverter may be damaged.
- Please check that the cable used is sufficient for the requirements, too thin, poor quality cables are a serious safety hazard.

4.5 PV connection

Connect the positive and negative wires of the two strings of PV according to the diagram below.

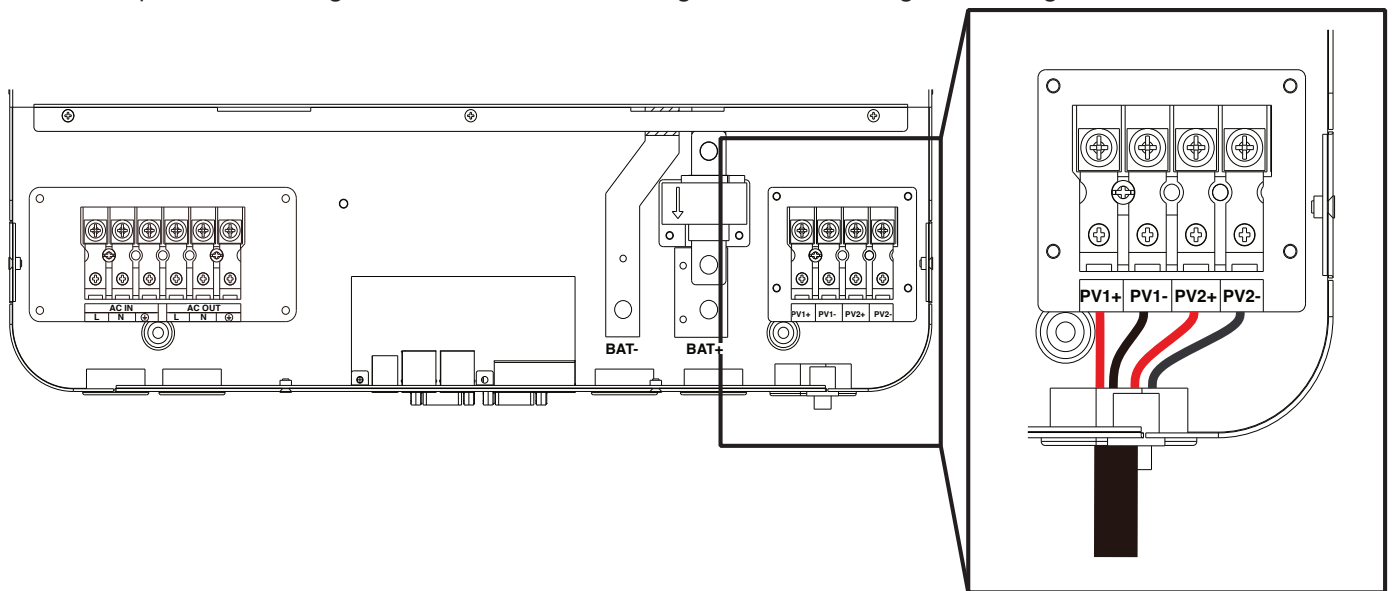

⚠ DANGER

- Before connecting PV, the circuit breaker must be opened to avoid the risk of electric shock and must not be operated with electricity.
- Please make sure that the open circuit voltage of the PV modules in series does not exceed the **Max. Open Circuit Voltage** of the inverter (In the ASF series, this value is 500V), otherwise the inverter may be damaged.

4.6 Dry contact connection

Use a small screwdriver to push back the direction indicated by the arrow, then insert the communication cable into the dry junction port. (Communication cable diameter 0.2~1.5mm²)

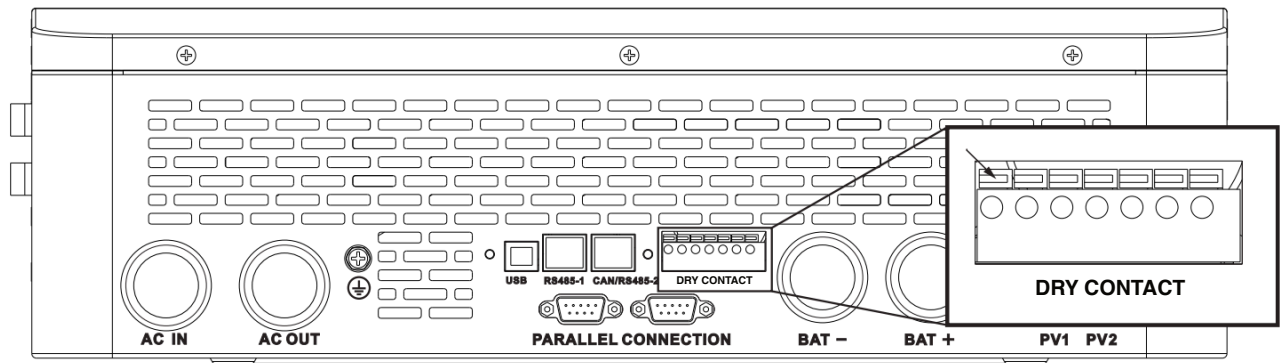

4.7 Grounding connection

Please make sure the grounding terminal connect to the Grounding Bar.

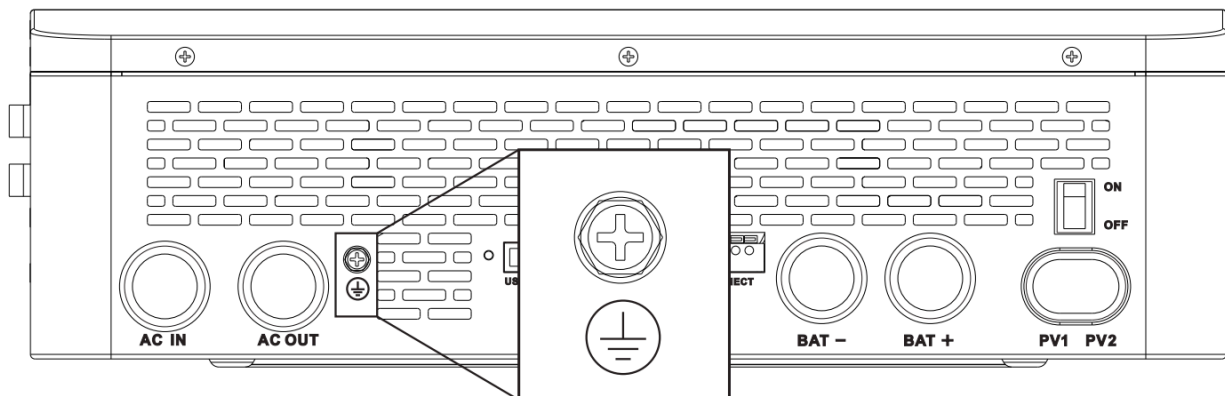

NOTICE

- The grounding cable should have a diameter of not less than 4 mm² and be as close as possible to the grounding point.

4.8 Final assembly

After ensuring that the wiring is reliable and the wire sequence is correct, install the terminal protection cover in place.

4.9 Start up the inverter

- **Step 1:** Close the circuit breaker of the battery.
- **Step 2:** Press the rocker switch on the bottom of inverter, the screen and indicators light up to indicate that the inverter has been activated.
- **Step 3:** Sequential close of the circuit breakers for PV, AC input and AC output.
- **Step 4:** Start the loads one by one in order of power from small to large.



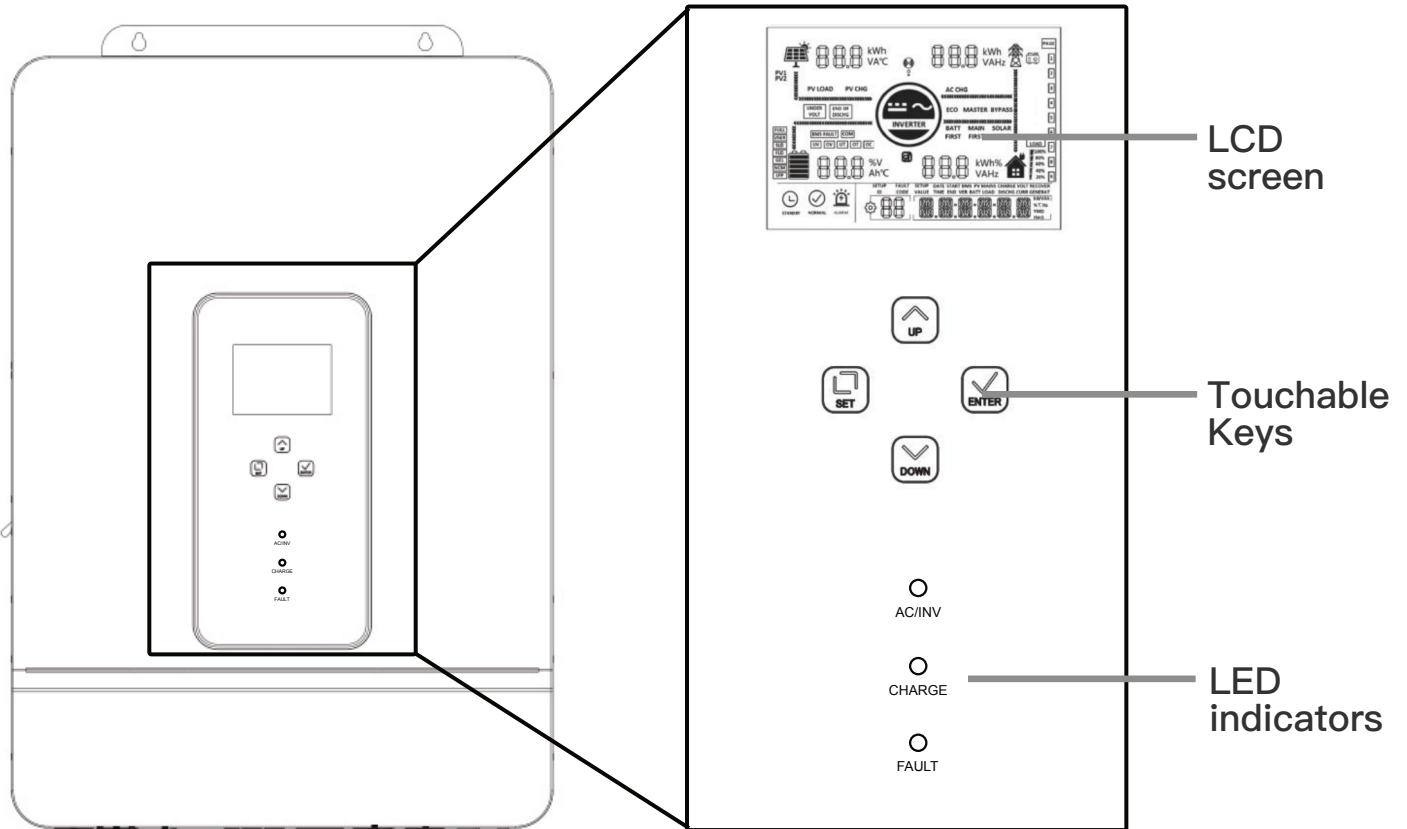

5. Operation

5.1 Operation and display panel

The operation and display panel below includes 1 LCD screen, 3 indicators, 4 touchable keys.



- **Touchable Keys**







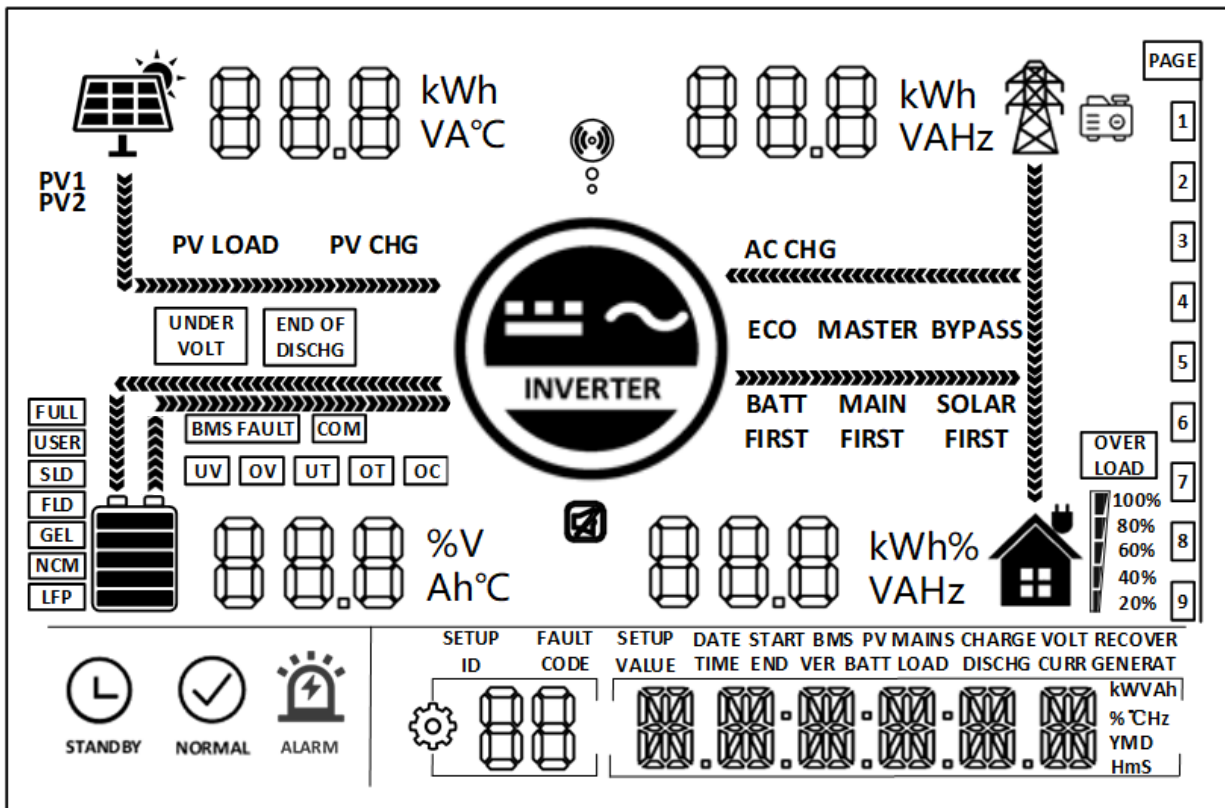

Touchable Keys	Description
	To enter/exit the setting menu
	To next selection
	To last selection
	To confirm/enter the selection in setting menu

























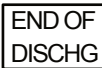





• LED Indicators

Indicators	Color	Description
AC/INV	Green	Continued: utility grid by-pass output
		Flash: inverter output
CHARGE	Yellow	Continued: charging complete
		Flash: charging
FAULT	Red	Flash: error occur

• Display panel



Icon	Description	Icon	Description
	Indicates the PV panel		Indicates the utility grid
	Indicates the battery		Indicates the generator
	Indicates the inverter is working		Indicates the home load
	Indicates the inverter is communicating with data collector		Indicates the buzzer muted
	Indicates the direction of energy flow		

Icon	Description	Icon	Description
 STANDBY	Indicates the inverter is standby	 NORMAL	Indicates the inverter is working normally
 ALARM	Indicates error occur		Indicates setting
	Indicates load power 80%~100%		Indicates battery SOC 80%~100%
	Indicates load power 60%~79%		Indicates battery SOC 60%~79%
	Indicates load power 40%~59%		Indicates battery SOC 40%~59%
	Indicates load power 20%~39%		Indicates battery SOC 20%~39%
	Indicates load power 5%~19%		Indicates battery SOC 5%~19%
	Indicates battery under-voltage		Indicates battery discharge
	Indicates over-load		Indicates BMS fault
	Indicates system communication error		Indicates system under-voltage
	Indicates system over-voltage		Indicates system under-temperature
	Indicates system over-temperature		Indicates system over-current
	Indicates battery is full		Indicates user defined battery
	Indicates sealed lead-acid battery		Indicates flooded lead-acid battery
	Indicates gel lead-acid battery		Indicates ternary li-ion battery
	Indicates LFP li-ion battery	ECO	Indicates energy-saving mode
PV LOAD	Indicates PV energy is carrying the load	PV CHG	Indicates PV energy is charging the battery
AC CHG	Indicates AC IN energy is charging the battery	MAIN FIRST	Indicates the inverter output mode is mains power first
BYPASS	Indicates the inverter output mode is bypass	SOLAR FIRST	Indicates the inverter output mode is solar first
BATT FIRST	Indicates the inverter output mode is battery first		

- View real-time data

In the main screen, press the UP / DOWN keys to view the real-time data of the inverter during operation.

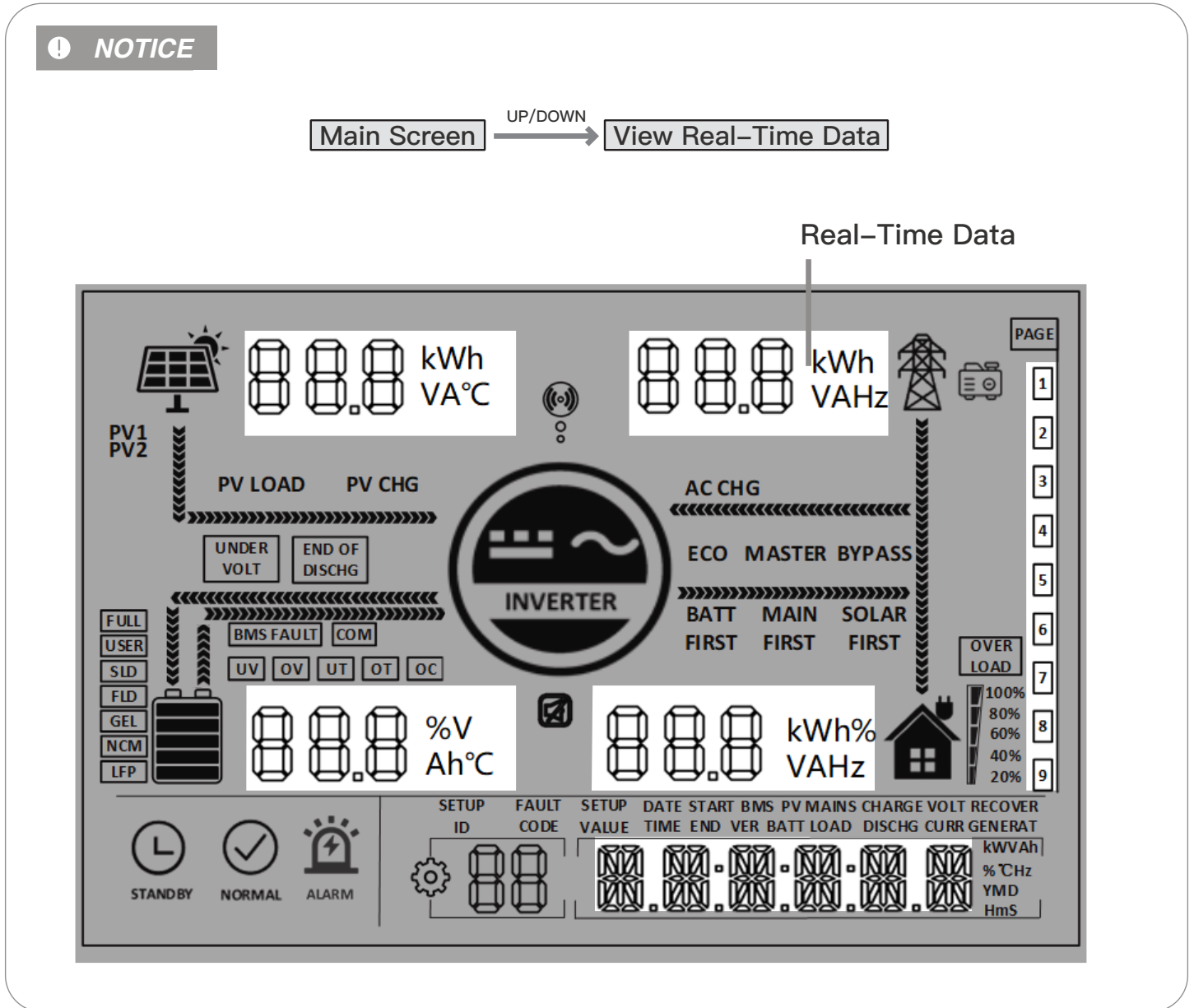

Page	PV side	BAT side	AC IN side	LOAD side	General
1	PV voltage	Batt Voltage	AC in voltage	Single phase voltage	Current Time
2	PV current	Batt Current	AC in current	Single phase Current	Current Date
3	PV power	Batt Voltage	Total AC charging power	Single phase active power	PV Total kWh
4	PV today kWh	Batt Current	Today AC charging kWh	Single phase apparent power	Load Total kWh
5	PV side heat sink temperature	INV Heat Sink Temperature	AC frequency	AC output frequency	RS485 Address
6	PV rated voltage	Batt Rated Voltage	Busbar voltage	AC output rated power	Software Version
7	Max. PV charging current	Max. Batt charging current	Max. AC charging Current	Total AC output active power	/
8			/	Total AC output apparent power	/

5.2 Setting

NOTICE

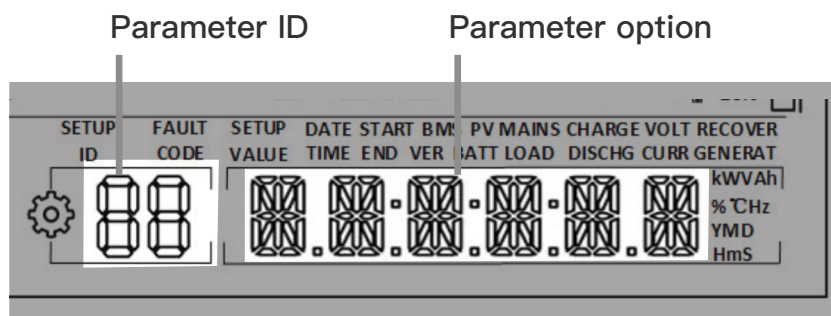
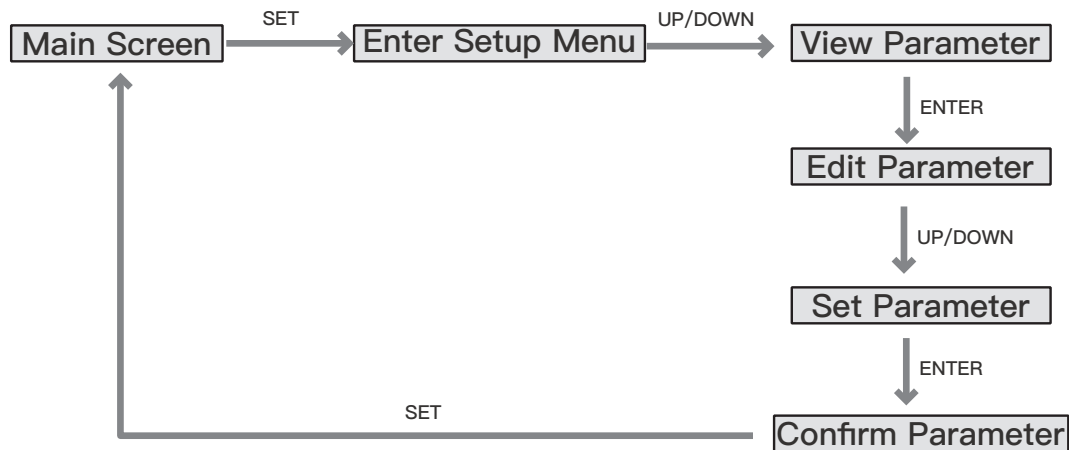

ID	Parameter Meaning	Options	Description
00	Exit	ESC	Exit the setup menu.
01	AC output source priority	UTI <i>default</i>	Utility at first priority, utility and solar provide power to load at the same time when solar is available, battery will provide power to load only when utility power is not available.
		SbU	Solar power and battery at first priority, Utility will provide power to load when solar power is not available and the battery voltage below parameter [04] value.
		SOL	Solar power at first priority, Utility will provide power to load when solar power is not available and the battery voltage below parameter [04] value .
02	AC output frequency	50.0	AC output frequency will adaptive utility frequency in bypass mode. Otherwise the output will follow the preset value.
		60.0 <i>default</i>	

ID	Parameter Meaning	Options	Description
03	AC input voltage range	UPS <i>default</i>	When output range is 220/230V, input voltage range 170~280V
		APL	When output range is 220/230V, input voltage range 90~280V
04	Voltage point of battery switch to utility	43.6	When parameter $\text{U1} = 5bU/50L$, output source will switch to utility from battery when the battery voltage below the preset value. Setting range:40~60V
05	Voltage point of utility switch to battery	56.8	When parameter $\text{U1} = 5bU/50L$, output source will switch to battery from utility when the battery voltage above the preset value. Range:40~60V
06	Battery charging mode	SNU <i>default</i>	Solar and utility charging the battery at the same time, solar at the first priority, utility power as a supplement when solar power is not sufficient. Notice: Solar and utility charging the battery at the same time only in bypass mode, only solar charging can be used when the invert circuit is in operation.
		CUB	Utility is the first priority in charging, Solar charging the battery only when utility is not available.
		CSO	Solar is the first priority in charging, Utility charging the battery only when solar is not available.
		OSO	Only solar charging the battery.
07	Battery charging current	60	ASF4880S180-H current setting range:0~180A
			ASF48100S200-H current setting range:0~200A.
08	Battery type	USER	User-defined, user can set all battery parameter.
		SLd	Sealed lead-acid battery.
		FLd	Flooded lead-acid battery.
		GEL <i>default</i>	Gel lead-acid battery.
		L14/L15/L16	LFP li-ion battery, 14\15\16 corresponds battery cells number in series.
		N13/N14	Ternary li-ion battery.
09	Battery bulk charging voltage	57.6	Setting range:48V~58.4V, increment of each click is 0.4V, parameter can be set only when battery type is USER and L14/L15/L16, N13/N14
10	Battery bulk charging delay time	120	Indicates the duration when battery voltage reached parameter U9 value in bulk charging procession, Setting range: 5min~900min, increment of each click is 5min, parameter can be set only when battery type is USER and L14/L15/L16, N13/N14
11	Battery float charging voltage	55.2	Setting range: 48V~58.4V, parameters cannot be set only after successful BMS communication.

ID	Parameter Meaning	Options	Description
12	Battery over-discharge voltage (delay off)	42	When the battery voltage falls below this voltage point and parameter 13 value is reached, the inverter output will be switched off. Setting range: 40V~48V, increment of each click is 0.4V, parameter can be set only when battery type is USER and L14/15/16, N13/14
13	Battery over-discharge voltage delay time	5	Indicates the duration when battery voltage reached parameter 12 value in over-voltage procession. Setting range: 5s~50s, increment of each click is 5s, parameter can be set only when battery type is USER and LFP14/15/16, N13/14
14	Battery under-voltage alarm	44	When the battery voltage falls below this voltage point, alarm will be displayed on the screen and indicator. Setting range: 40V~52V, increment of each click is 0.4V, parameter can be set only when battery type is USER and L14/15/16, N13/14
15	Battery under-voltage limit voltage	40	When the battery voltage falls below this voltage point, the inverter output is switched off immediately. Setting range is 40V~52V, increment of each click is 0.4V, parameter can be set only when battery type is USER and L14/15/16, N13/14
16	Battery equalization charging	DIS	Disable equalization charging.
		ENA <i>default</i>	Enable equalization charging, parameter can be set only when battery type is FLdVSLdUSER
17	Battery equalization charging voltage	58	Setting range: 48V~58V, increment of each click is 0.4V, parameter can be set only when battery type is FLdVSLdUSER
18	Battery equalization charging duration	120	Setting range: 5min~900min, increment of each click is 5min, parameter can be set only when battery type is FLdVSLdUSER
19	Battery equalization charging delay time	120	Setting range: 5min~900min, increment of each click is 5min, parameter can be set only when battery type is FLdVSLdUSER
20	Battery equalization charging interval	30	Setting range: 0~30 days, increment of each click is 1 day, parameter can be set only when battery type is FLdVSLdUSER
21	Battery equalization charging stop-start	DIS <i>default</i>	Stop equalization charging immediately.
		ENA	Start equalization charging immediately.
22	Power saving mode	DIS <i>default</i>	Disable power saving mode.
		ENA	Enable power saving mode, When the load power below 50W, the inverter output will switch off after a 5min delay . When the load is more than 50W, the inverter automatic restart.
23	Over-load restart	DIS	When overload occurs and the output is switched off, the machine will not restart.
		ENA <i>default</i>	When overload occurs and the output is switched off, the machine will restart after a delay of 3 minutes. After it reaches 5 cumulative time, the machine will not restart automatically.

ID	Parameter Meaning	Options	Description
24	Over-temperature restart	dIS	When over temperature occurs and the output is switched off, the machine will not restart.
		ENA <i>default</i>	When overload occurs and the output is switched off, the machine will restart when the temperature drops.
25	Buzzer alarm	dIS	Disable buzzer alarm.
		ENA <i>default</i>	Enable buzzer alarm.
26	Power source switching reminder	dIS	Disable reminder when the status of the input power source changes.
		ENA <i>default</i>	Enable reminder when the status of the input power source changes.
27	Inverter overload switch to bypass	dIS	Disable switch to the bypass when the inverter is overload.
		ENA <i>default</i>	Enable switch to the bypass when the inverter is overload.
28	Max. utility charging current	60	ASF4880S180-H, setting range: 0~100A.
			ASF48100S200-H, setting range: 0~120A.
30	RS485 address	Id: 1	RS485 address setting range: 1~254.
32	RS485 communication	SLA <i>default</i>	Enabling PC and remote monitoring protocols
		485	Enabling BMS communication based on RS485
		CAN	Enabling BMS communication based on CAN
33	BMS communication	When item 32 is set to 485 or CAN, the corresponding communication protocol must be selected in item 33	
		PAC=PACE, RDA=Ritar, AOG=ALLGRAND BATTERY, OLT=OLITER, HWD=SUNWODA, DAQ=DAKING, WOW=SRNE, PYL=PYLONTECH UOL=WEILAN	
34	Feed back & hybrid output function	dIS <i>default</i>	Disable this function.
		MIX LOd	Hybrid output mode When parameter 01 =011, the solar energy is prioritised to charge the batteries and any excess energy will be used to power the load. With an anti-backflow function, the PV energy is not feed back into the grid.
		ON GRd	On-grid function When parameter 01 =011, solar energy will feed back into the grid when battery is full or disconnected.
35	Battery under voltage recover point	52	Battery recover discharge from under voltage protection when voltage above this value. Setting range: 44V~54V.
37	Battery full recharge voltage point	52	Inverter stops charging when the battery is full. Inverter resumes charging when the battery voltage below this value. Setting range: 44V~54V.
38	AC output voltage	230	Setting range: 200/208/220/230/240Vac

ID	Parameter Meaning	Options	Description
40	1st slot start charging	00:00:00	Setting range: 00:00:00–23:59:00
41	1st slot end charging	00:00:00	Setting range: 00:00:00–23:59:00
42	2nd slot start charging	00:00:00	Setting range: 00:00:00–23:59:00
43	2nd slot end charging	00:00:00	Setting range: 00:00:00–23:59:00
44	3rd slot start charging	00:00:00	Setting range: 00:00:00–23:59:00
45	3rd slot end charging	00:00:00	Setting range: 00:00:00–23:59:00
46	Time slot charging function	dIS <i>default</i>	Disable this function.
		ENA	Enable this function, AC output source mode will switch to 5bU, utility charging the battery and carry load only in charging time slot which user set or the battery is under voltage.
47	1st slot start discharging	00:00:00	Setting range: 00:00:00–23:59:00
48	1st slot end discharging	00:00:00	Setting range: 00:00:00–23:59:00
49	2nd slot start discharging	00:00:00	Setting range: 00:00:00–23:59:00
50	2nd slot end discharging	00:00:00	Setting range: 00:00:00–23:59:00
51	3rd slot start discharging	00:00:00	Setting range: 00:00:00–23:59:00
52	3rd slot end discharging	00:00:00	Setting range: 00:00:00–23:59:00
53	Time slot discharging function	dIS <i>default</i>	Disable this function.
		ENA	Enable this function, AC output source mode will switch to UTI, battery discharging only in discharging time slot which user set or utility is not available.
54	Local date	00:00:00	YY/MM/DD. Setting range: 00:01:01–99:12:31
55	Local time	00:00:00	Setting range: 00:00:00–23:59:59
57	Stop charging current	2	Charging stops when the charging current is less than the set value (unit:amp)
58	Discharging alarm SOC	15	Triggers an alarm when the battery SOC is less than the set value (unit:%)
59	Discharging cutoff SOC	5	Stops discharging when the battery SOC is less than the set value (unit:%)
60	Charging cutoff SOC	100	Stops charging when the battery SOC is touch the set value (unit:%)
61	Switching to utility SOC	10	Switch to utility power when the battery SOC is less than this setting (unit:%)
62	Switching to inverter SOC	100	Switches to inverter output mode when SOC is greater than this setting (unit:%)
63	N–PE bonding automatic switching function	dIS <i>default</i>	Allow automatic switching of N–PE bonding
		ENA	Prohibit automatic switching of N–PE bonding

*SOC: State of charge

Options 58-62 only take effect after successful communication from the BMS

5.3 AC output mode

The AC output mode corresponds to parameter setting item 01 and 34, which allows the user to set the AC output power source manually.

- **Utility Priority Output 01 UTI (default)**

Utility at first priority, utility and solar provide power to load at the same time when solar is available, battery will provide power to load only when utility power is not available. (Priority: utility>solar>battery)

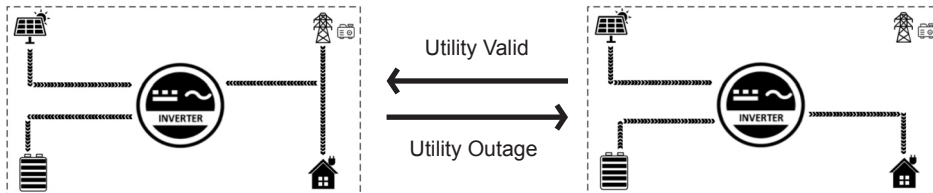

- **Solar and Utility Hybrid Output 34 MIX LOD**

In **UTI** mode, when not connected to the battery or when the battery is full, the solar and the utility supply power to the load at the same time. (Priority: solar>utility>battery)



- **Solar Priority Output 01 SOL**

Solar provides power to the loads as first priority. If solar is not available, the utility grid will provide power to the loads. This mode maximises solar energy while maintaining battery power and is suitable for areas with relatively stable power grids. (Priority: solar>utility>battery)

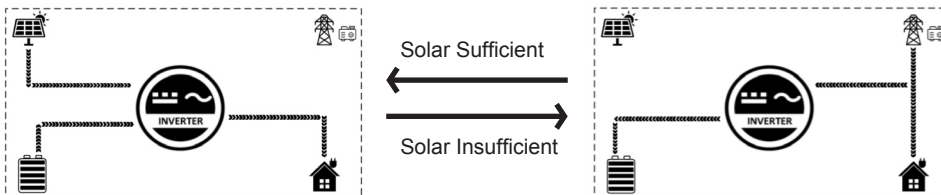

- **Inverter Priority Output 01 SbU**

Solar provides power to the loads as first priority. If solar is not sufficient or not available, the battery will be used as a supplement to provide power to the loads. When the battery voltage reaches the value of parameter 04 (Voltage point of battery switch to utility) will switch to utility to provide power to the load. This model makes maximum use of DC energy and is used in areas where the grid is stable. (Priority: solar>battery>utility)

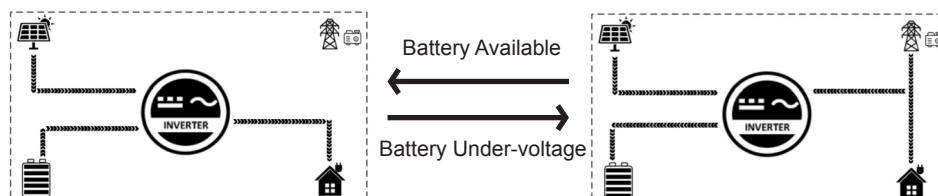

5.4 Battery charging mode

The charging mode corresponds to parameter setting item 06, which allows the user to set the charging mode manually.

- **Hybrid Charging SNU (default)**

Solar and utility charging the battery at the same time, solar at the first priority, utility power as a supplement when solar power is not sufficient. This is the fastest way to charge and is suitable for areas with low power supply, providing customers with sufficient back-up power. (Source priority: solar > utility)

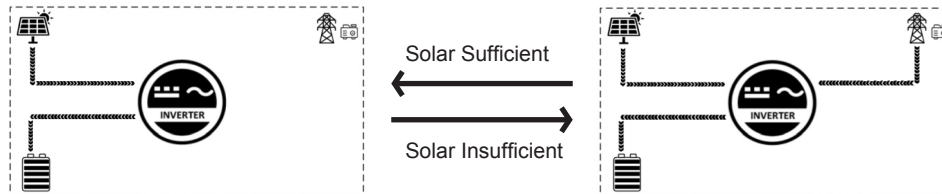

- **Utility Priority Charging CUb**

The utility power gives priority to charging the battery, and PV charging is only activated when the utility power is not available. (Source priority: utility > solar)

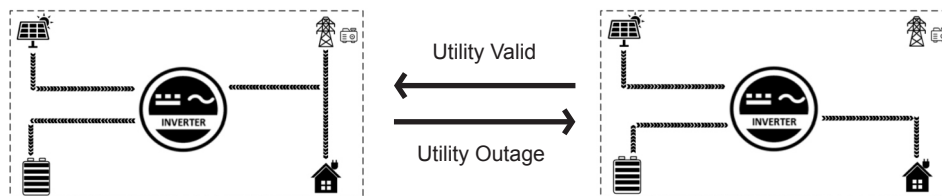

- **Solar Priority Charging CSO**

Solar priority charging, with utility charging only activated when the solar fails. By making full use of solar power during the day and switching to utility charging at night, battery power can be maintained and is suitable for applications in areas where the grid is relatively stable and electricity prices are more expensive. (Source priority: solar > utility)

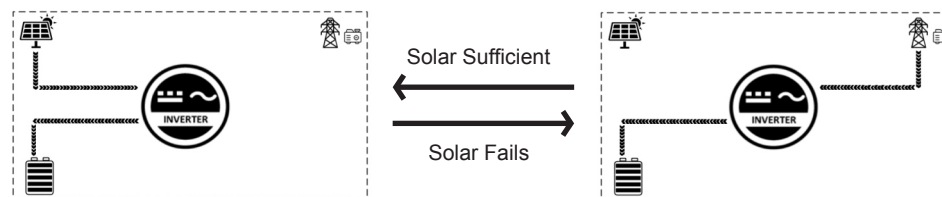

- **Only Solar Charging OSO**

Solar charging only, no mains charging is activated. This is the most energy-efficient method, with all the battery power coming from solar energy, and is usually used in areas with good radiation conditions.

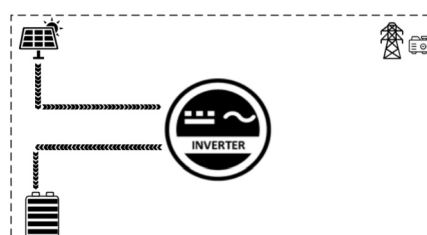

5.5 Time-slot charging/discharging function

The ASF series is equipped with a time-slot charging and discharging function, which allows users to set different charging and discharging periods according to the local peak and valley tariffs, so that the utility power and PV energy can be used rationally.

When mains electricity is expensive, the battery inverter is used to carry the load; when the mains electricity is cheap, the mains electricity is used to carry the load and charge, which can help customers to save electricity costs to the greatest extent.

The user can turn on/off the time-slot charging/discharging function in setup menu parameter 46 and 53, and set charging and discharging slot in parameter 40-45, 47-52. Below are examples for users to understand the function.

NOTICE

Before using this function for the first time, please set the local time in parameter items 54, 55, then the user can set the corresponding time slot according to the local peak and valley tariff charges.

Peak-Valley Electricity Tariff

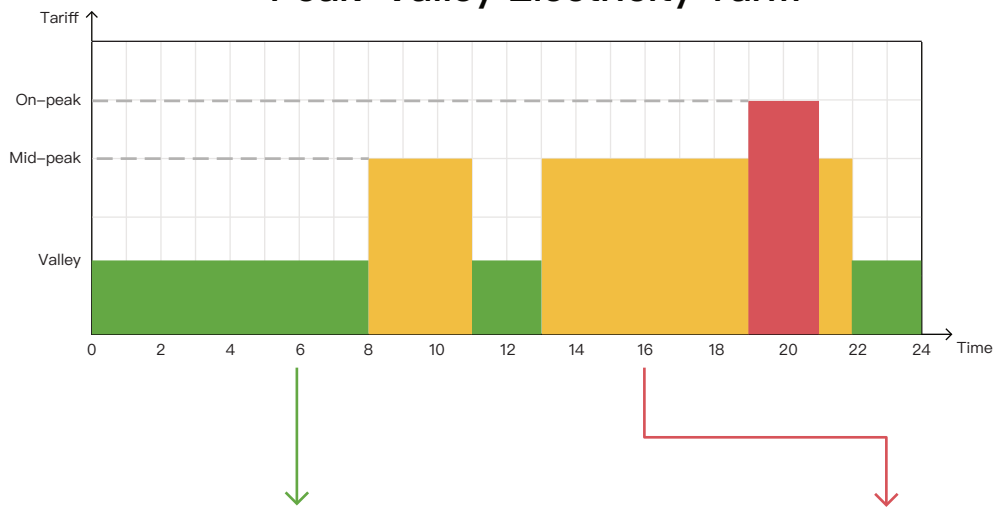

Time-slot Utility Charging/Carrying Function



With 3 definable periods, the user can freely set the mains charging/carrying time within the range of 00:00 to 23:59. During the time period set by the user, if PV energy is available, PV energy will be used first, and if PV energy is not available or insufficient, utility energy will be used as a supplement.

Time-slot Battery Discharging Function



With 3 definable time periods, users can freely set the battery discharge time within the range of 00:00 to 23:59. During the time period set by the user, the inverter will give priority to the battery inverter to carry the load, and if the battery power is insufficient, the inverter will automatically switch to mains power to ensure stable operation of the load.

5.6 Battery parameter

- Lead-acid battery

Parameter/Battery type	Sealed	Gel	Flooded	User-defined
	SLd	GEL	FLd	USER
Over-voltage cut-off voltage	60V	60V	60V	60V
Equalization charging voltage	58V	56.8V	58V	40~60V settable
Bulk charging voltage	57.7V	56.8V	57.6V	40~60V settable
Float charging voltage	55.2V	55.2V	55.2V	40~60V settable
Under-voltage alarm voltage	44V	44V	44V	40~60V settable
Under-voltage cut-off voltage	42V	42V	42V	40~60V settable
Discharging limit voltage	40V	40V	40V	40~60V settable
Over-discharge delay time	5s	5s	5s	1~30s settable
Equalization charging duration	120min	-	120min	0~600min settable
Equalization charging interval	30d	-	30d	0~250d settable
Bulk charging duration	120min	120min	120min	10~600m settable

NOTICE

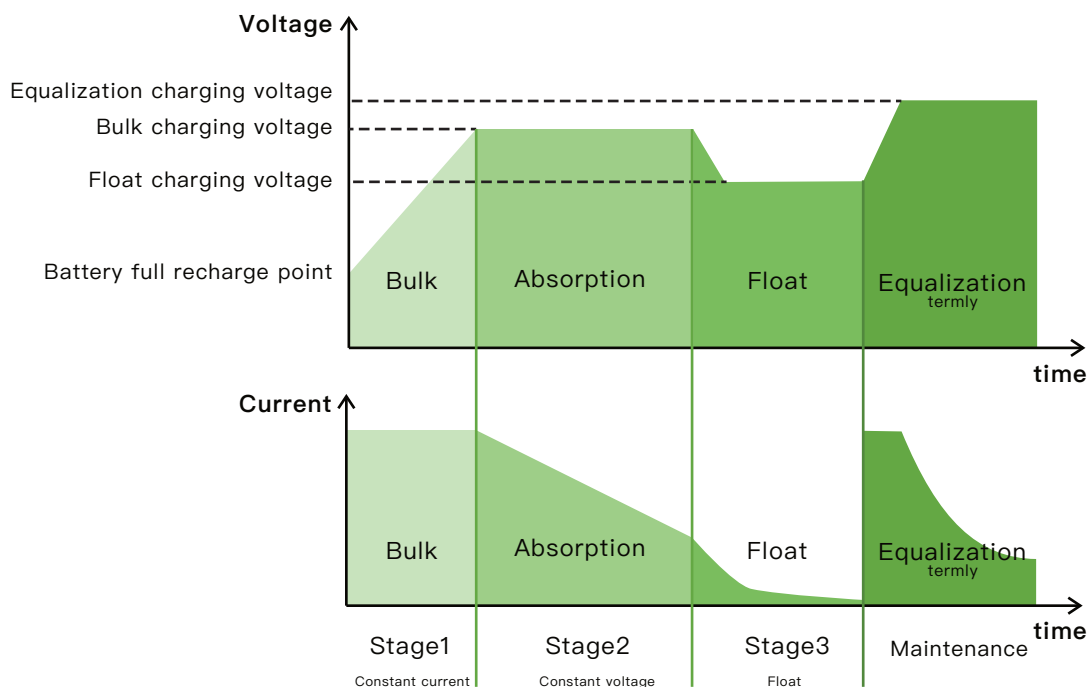

- Li-ion battery

Parameter/Battery type	Ternary		LFP			User-defined
	N13	N14	L16	L15	L14	USER
Over-voltage cut-off voltage	60V	60V	60V	60V	60V	60V
Equalization charging voltage	-	-	-	-	-	40~60V settable
Bulk charging voltage	53.2V	57.6V	56.8V	53.2V	49.2V	40~60V settable
Float charging voltage	53.2V	57.6V	56.8V	53.2V	49.2V	40~60V settable
Under-voltage alarm voltage	43.6V	46.8V	49.6V	46.4V	43.2V	40~60V settable
Under-voltage cut-off voltage	38.8V	42V	48.8V	45.6V	42V	40~60V settable
Discharging limit voltage	36.4V	39.2V	46.4V	43.6V	40.8V	40~60V settable
Over-discharge delay time	30s	30s	30s	30s	30s	1~30s settable
Equalization charging duration	-	-	-	-	-	0~600min settable
Equalization charging interval	-	-	-	-	-	0~250d settable
Bulk charging duration	120min settable	120min settable	120min settable	120min settable	120min settable	10~600min settable

NOTICE

If no BMS is connected, the inverter will charge according to the battery voltage with a preset charging curve. When the inverter communicates with the BMS, it will follow the BMS instructions to perform a more complex stage charging process.

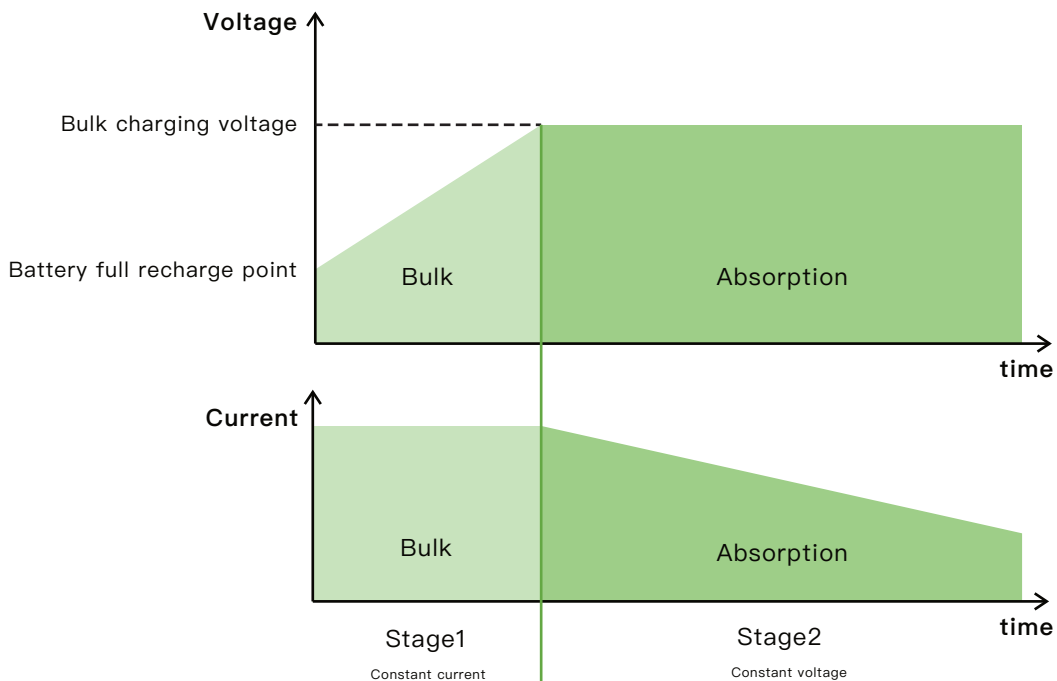

6. Communication

6.1 Overview

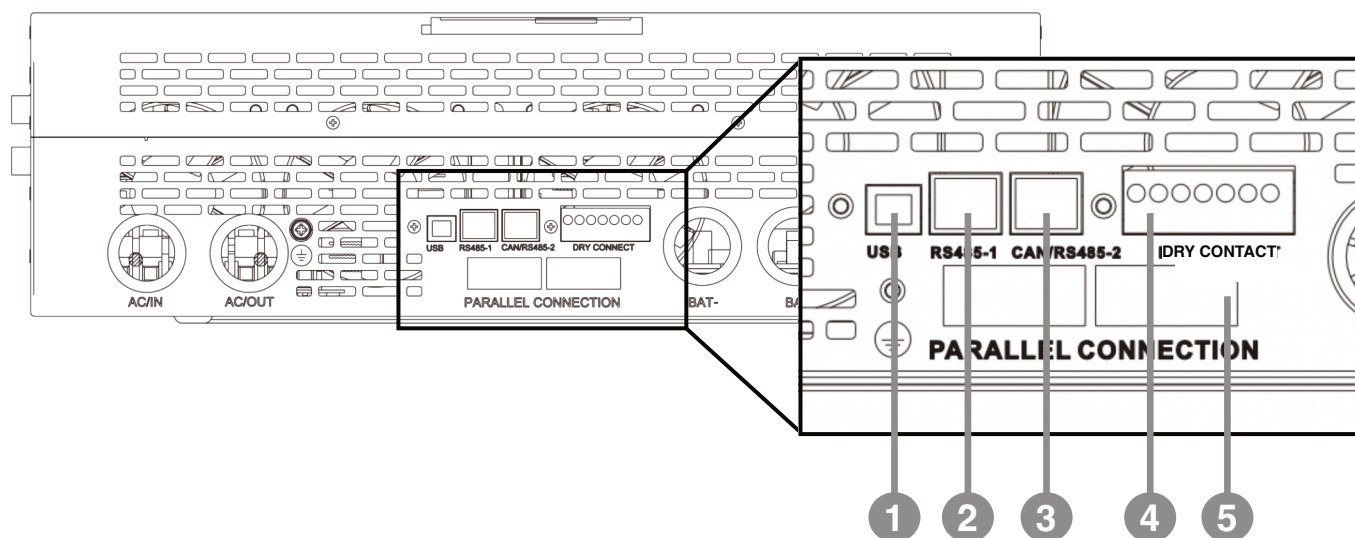

1	USB-B port	2	RS485-1 port	3	RS485-2 port
4	Dry contact port	5	Parallel connection port (reserved port, this model does not support parallel connection)		

6.2 USB-B port

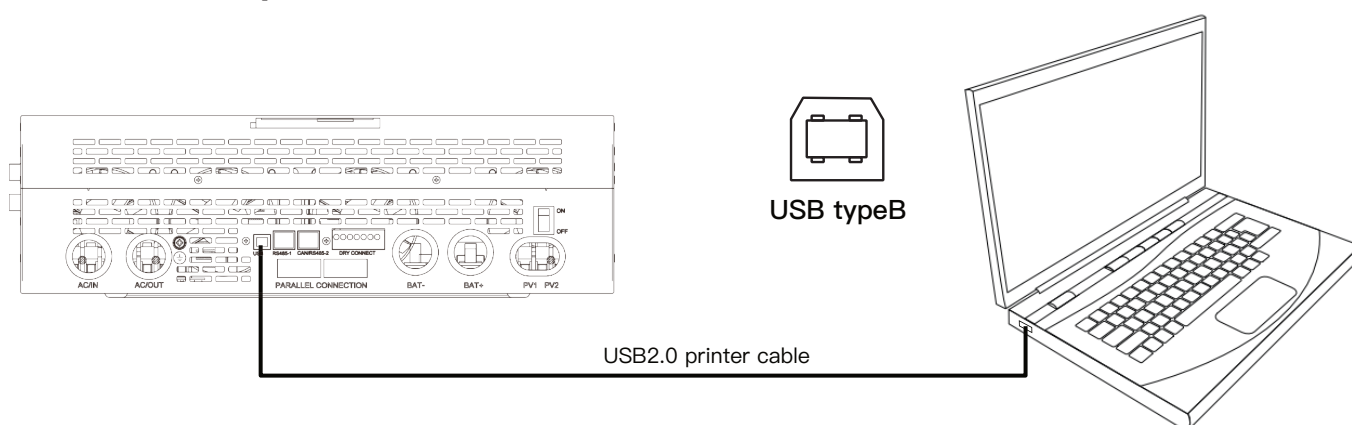

The user can read and modify device parameters through this port by using the host software. Please contact us for the host software installation package if you require one.

6.3 RS485-1 port

The RS485-1 port is used to connect to the Wi-Fi/GPRS data acquisition module, which allows the user to view the operating status and parameters of the inverter via the mobile phone APP.

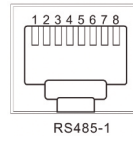
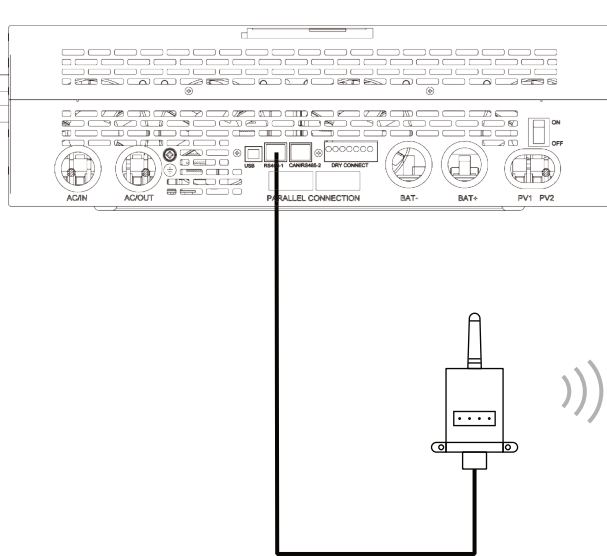

RJ45	Definition
Pin 1	5V
Pin 2	GND
Pin 3	/
Pin 4	/
Pin 5	/
Pin 6	/
Pin 7	RS485-A
Pin 8	RS485-B

NOTICE

The Wi-Fi/GPRS data acquisition module need to be purchased separately. User can scan the QR code to download the mobile APP.



6.4 CAN/RS485-2 port

The RS485-2 port is used to connect to the BMS of Li-ion battery.

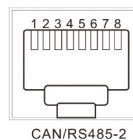

RJ45	Definition
Pin 1	5V
Pin 2	GND
Pin 3	/
Pin 4	CANH
Pin 5	CANL
Pin 6	/
Pin 7	RS485-A
Pin 8	RS485-B

NOTICE

If you need the inverter to communicate with the lithium battery BMS, please contact us for the communication protocol or to upgrade the inverter to the corresponding software program.

If you use a normal RJ45 network cable, please check the pin assignment, pin 1 & pin 2 usually need to be cut off for normal use.

6.5 Dry contact

Dry contact port with 4 functions:

1. Remote switch on/off
2. Switching signal output
3. Battery temperature sampling
4. Generator remote start/stop

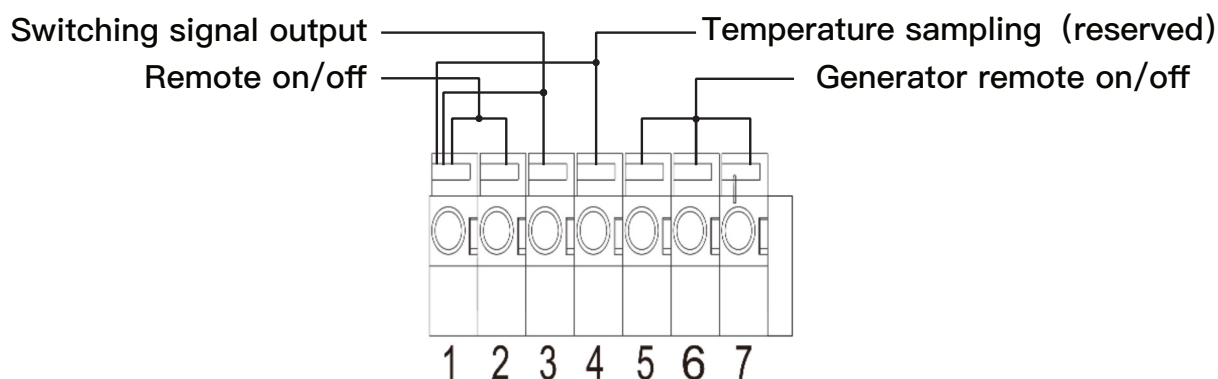

Function	Description
Remote switch on/off	When pin 1 is connected with pin 2, the inverter will be switched off the AC output. When pin 1 is disconnected from pin 2, the inverter outputs normally.
Switching signal output	When the voltage of battery reaches the <i>under-voltage limit voltage</i> (parameter 15), pin 3 to pin 1 voltage is 0V, When the battery charging/discharging normally pin 3 to pin 1 voltage is 5V.
Temperature sampling (reserved)	Pin 1 & Pin 4 can be used for battery temperature sampling compensation.
Generator remote start/stop	When the voltage of battery reaches the <i>under-voltage alarm voltage</i> (parameter 14) or <i>voltage point of utility switch to battery</i> (parameter 14), pin 6 to pin 5 normal open, pin 7 to pin 5 normal close. When the voltage of battery reaches the <i>voltage point of battery switch to utility</i> (parameter 15) or battery is full. pin 6 to pin 5 normal close, pin 7 to pin 5 normal open. (Pin 5/6/7 outputs 125Vac/1A, 230Vac/1A, 30Vdc/1A)

NOTICE

If you need to use the remote start/stop function of the generator with dry contact, ensure that the generator has ATS and supports remote start/stop.

7. Fault and Remedy

7.1 Fault code

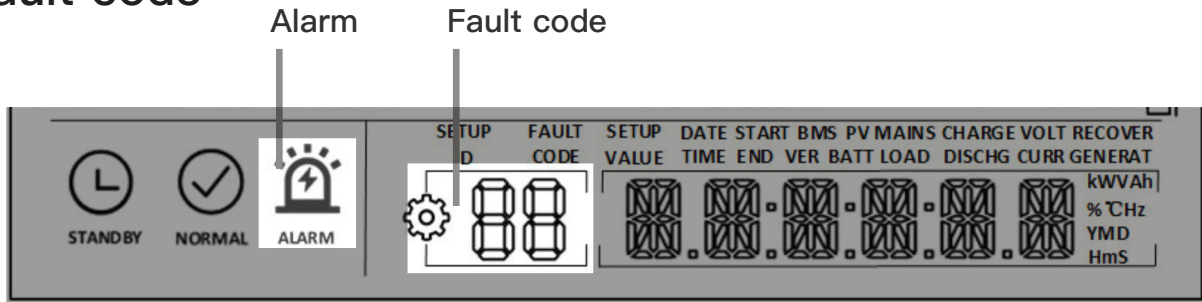

Fault Code	Meaning	Does it Affect the outputs	Instructions
01	BatVoltLow	Yes	Battery under-voltage alarm
02	BatOverCurrSw	Yes	Battery discharge over-current, software protection
03	BatOpen	Yes	Battery disconnected alarm
04	BatLowEod	Yes	Battery under-voltage stop discharging alarm
05	BatOverCurrHw	Yes	Battery over-current hardware protection
06	BatOverVolt	Yes	Battery over-voltage protection
07	BusOverVoltHw	Yes	Busbar over-voltage hardware protection
08	BusOverVoltSw	Yes	Busbar over-voltage software protection
09	PvVoltHigh	Yes	PV input over-voltage protection
10	PvBoostOCSw	No	Boost circuit over-current software protection
11	PvBoostOCHw	No	Boost circuit over-current hardware protection
12	SpiCommErr	Yes	Master-slave chip SPI communication failure
13	OverloadBypass	Yes	Bypass overload protection
14	OverloadInverter	Yes	Inverter overload protection
15	AcOverCurrHw	Yes	Inverter over-current hardware protection
16	AuxDspReqOffPWM	Yes	Slave chip request switch off failure
17	InvShort	Yes	Inverter short-circuit protection
18	Bussoftfailed	Yes	Inverter busbar soft start failed
19	OverTemperMppt	No	MPPT heat sink over-temperature protection
20	OverTemperInv	Yes	Inverter heat sink over-temperature protection
21	FanFail	Yes	Fan failure
22	EEPROM	Yes	Reservoir failure

Fault Code	Meaning	Does it Affect the outputs	Instructions
23	ModelNumErr	Yes	Wrong model
24	Busdiff	Yes	Busbar voltage imbalance
25	BusShort	Yes	Busbar short circuit
26	Rlyshort	Yes	Inverter output back flow to bypass
28	LinePhaseErr	Yes	Utility input phase fault
29	BusVoltLow	Yes	Busbar under-voltage protection
30	BatCapacityLow1	No	Battery SOC below 10% alarm (Only enable BMS take effect)
31	BatCapacityLow2	No	Battery SOC below 5% alarm (Only enable BMS take effect)
32	BatCapacityLowStop	Yes	Battery dead (Only enable BMS take effect)
58	BMSComErr	No	BMS communication failure
59	BMSErr	No	BMS failures occur
60	BMSUnderTem	No	BMS under-temperature alarm (Only enable BMS take effect)
61	BMSOverTem	No	BMS over-temperature alarm (Only enable BMS take effect)
62	BMSOverCur	No	BMS over-current alarm (Only enable BMS take effect)
63	BMSUnderVolt	No	BMS under-voltage alarm (Only enable BMS take effect)
64	BMSOverVolt	No	BMS over-voltage alarm (Only enable BMS take effect)

7.2 Troubleshooting

Fault Code	Meaning	Causality	Remedy
/	Screen no display	No power input, or in sleep mode.	Closing the circuit breaker. Ensure the rocker switch is ON. Push any button on the panel to exit sleep mode.
01	Battery under-voltage	The battery voltage is lower than the value set in parameter [14].	Charge the battery and wait until the battery voltage is higher than the value set in the parameter item [14].
03	Battery not connected	The battery is not connected, or the BMS in discharge protection	Check whether the battery is reliably connected; check whether the circuit breaker of the battery is not closed; ensure that the BMS of the Li-ion battery can communicate properly.

Fault Code	Meaning	Causality	Remedy
04	Battery over-discharge	The battery voltage is lower than the value set in the parameter [12].	Manual reset: Power off and restart. Automatic reset: charge the battery so that the battery voltage is higher than the value set in the parameter item [35].
06	Battery over-voltage when charging	Battery is in over-voltage condition.	Manually power off and restart. Check to see if the battery voltage exceeds the limit. If it exceeds, the battery needs to be discharged until the voltage is below the battery's over-voltage recovery point.
13	Bypass over-load (software detection)	Bypass output power or output current overload for a certain period of time.	Reduce the load power and restart the device. Please refer to item 11 of the protection features for more details.
14	Inverter over-load (software detection)	Inverter output power or output current overload for a certain period of time.	
19	Heat sink of PV input over-temperature (software detection)	Heat sink of PV input temperature exceeds 90°C for 3s.	Resume normal charge and discharge when the temperature of the heat sink has cooled to below the over-temperature recovery temperature.
20	Heat sink of inversion over-temperature (software detection)	Heat sink of inversion temperature exceeds 90°C for 3s.	
21	Fan failure	Fan failure detects by hardware for 3s.	Manually toggle the fan after switching off to check for blockage by foreign objects.
26	AC Input relay short-circuit	Relay for AC input sticking	Manually power off and restart; if the fault reappears after restarting, You need to contact the after-sales service to repair the machine.
28	Utility input phase fault	AC input phase does not coincide with AC output phase	Ensure that the phase of the AC input is the same as the phase of the AC output, e.g. if the output is in split-phase mode, the input must also be in split-phase.

NOTICE

If you encounter a fault with the product that cannot be solved by the methods in the table above, please contact our after-sales service for technical support and do not disassemble the equipment yourself.

8. Protection and Maintenance

8.1 Protection features

No	Protection Feature	Instruction
1	PV input current/power limiting protection	When the charging current or power of the PV array configured exceeds the PV input rated value, the inverter will limit the input power and charge at the rated.
2	PV input over-voltage	If the PV voltage exceeds the maximum value allowed by the hardware, the machine will report a fault and stop the PV boost to output a sinusoidal AC wave.
3	PV night reverse current protection	At night, the battery is prevented from discharging through the PV module because the battery voltage is greater than the voltage of PV module.
4	AC input over-voltage protection	When the AC input voltage of each phase exceeds 280V, the mains charging will be stopped and switched to the inverter mode.
5	AC input under-voltage protection	When the AC input voltage of each phase below 170V, the utility charging will be stopped and switched to the inverter mode.
6	Battery over-voltage protection	When the battery voltage reaches the over-voltage cut-off point, the PV and the utility will automatically stop charging to prevent the battery from being overcharged and damaged.
7	Battery under-voltage protection	When the battery voltage reaches the under-voltage cut-off point, the inverter will automatically stop the battery discharge to prevent damage from over-discharging the battery.
8	Battery over-current protection	After a period when the battery current exceeds that allowed by the hardware, the machine will switch off the output and stop discharging the battery.
9	AC output short-circuit protection	When a short-circuit fault occurs at the load output terminal, the AC output is immediately turned off and turned on after 1 second. If the output load terminal is still short-circuited after 3 attempts, the inverter must be manually restarted after first removing the short-circuit fault from the load before the normal output can be restored.
10	Heat sink over-temperature protection	When the internal temperature of the inverter is too high, the inverter will stop charging and discharging; when the temperature returns to normal, the inverter will resume charging and discharging.
11	Inverter over-load protection	After triggering the overload protection the inverter will resume output after 3 minutes, 5 consecutive overloads will switch off the output until the inverter is restarted.

No	Protection Feature	Instruction
11	Inverter over-load protection	(102%<load<110%) ±10%: error and output shutdown after 5min; (110% < load < 125%) ±10%: error and output shutdown after 10s. Load > 125% ±10%: error reported and output switched off after 5s.
12	AC output reverse	Prevents AC back flow from the battery inverter to the bypass AC input.
13	Bypass over-current protection	Built-in AC input over-current protection circuit breaker.
14	Bypass phase inconsistency protection	When the phase of the bypass input and the phase of the inverter split do not match, the inverter disables switching to the bypass output to prevent the load from dropping out or short-circuiting when switching to the bypass.

8.2 Maintenance

To maintain optimum and long-lasting working performance, we recommend that the following items are checked twice a year.

1. Ensure that the airflow around the inverter is not blocked and remove any dirt or debris from the radiator.
2. Check that all exposed conductors are not damaged by sunlight, friction with other surrounding objects, dry rot, insect or rodent damage, etc. The conductors need to be repaired or replaced if necessary.
3. Verify that the indications and displays are consistent with the operation of the equipment, note any faults or incorrect displays and take corrective action if necessary.
4. Check all terminals for signs of corrosion, insulation damage, high temperatures or burning/discolouration and tighten terminal screws.
5. Check for dirt, nesting insects and corrosion, clean anti insects net as required.
6. If the lightning arrester has failed, replace the failed arrester in time to prevent lightning damage to the inverter or other equipment of the user.

DANGER

- Make sure that the inverter is disconnected from all power sources and that the capacitors are fully discharged before carrying out any checks or operations to avoid the risk of electric shock.

The Company shall not be liable for damage caused by :

1. Damage caused by improper use or use in a wrong location.
2. Photovoltaic modules with an open circuit voltage exceeding the maximum permissible voltage.
3. Damage caused by the operating temperature exceeding the restricted operating temperature range
4. Dismantling and repair of the inverter by unauthorised persons.
5. Damage caused by force majeure: damage during transport or handling of the inverter.

9. Datasheet

MODEL	ASF4880S180-H	ASF48100S200-H	CAN BE SET
INVERTER OUTPUT			
Rated Output Power	8,000W	10,000W	
Max.Peak Power	12,000W	15,000W	
Rated Output Voltage	220Vac(Single phase)		Y
Load Capacity of Motors	5HP	6HP	
Rated AC Frequency	50/60Hz		Y
Waveform	Pure Sine Wave		
Switch Time	10ms (typical)		
Parallel capacity	/		
Overload	<p>After triggering the overload protection the inverter will resume output after 3 minutes, 5 consecutive overloads will switch off the output until the inverter is restarted.</p> <p>(102%<load<110%) ±10%: error and output shutdown after 5min; (110% < load < 125%) ±10%: error and output shutdown after 10s. Load > 125% ±10%: error reported and output switched off after 5s.</p>		
BATTERY			
Battery Type	Li-ion / Lead-Acid / User Defined		Y
Rated Battery Voltage	48Vdc		
Voltage Range	40-60Vdc		Y
Max.MPPT Charging Current	180A	200A	Y
Max.Mains/Generator Charging Current	100A	120A	Y
Max.Hybrid Charging Current	180A	200A	Y
PV INPUT			
Num. of MPP Trackers	2		
Max.PV array power	11,000W		
Max.input current	22/22A		
Max.Voltage of Open Circuit	500Vdc		
MPPT Voltage Range	125-425Vdc		
MAINS / GENERATOR INPUT			
Input Voltage Range	90-275Vac		
Frequency Range	50/60Hz		
Bypass Overload Current	63A		
EFFICIENCY			
MPPT Tracking Efficiency	99.9%		
Max. Battery Inverter Efficiency	92%		

MODEL	ASF4880S180-H	ASF48100S200-H	CAN BE SET
GENERAL			
Dimensions	620*445*130mm (2*1.46*0.4ft)		
Weight	27kg (59.5lb)		
Protection Degree	IP20, Indoor Only		
Operating Temperature Range	-10~55°C, >45°C derated (14~131°F, >113°F derated)		
Noise	<60dB		
Cooling Method	Internal Fan		
Warranty	2 Years		
COMMUNICATION			
Embedded Interfaces	RS485 / CAN / USB / Dry contact		Y
External Modules (Optional)	Wi-Fi / GPRS		Y
CERTIFICATION			
Safety	IEC62109-1, IEC62109-2, UL1741		
EMC	EN61000-6-1, EN61000-6-3, FCC 15 class B		
RoHS	Yes		